

Modle : EJ1240Fe

● Outer dimensions (mm)

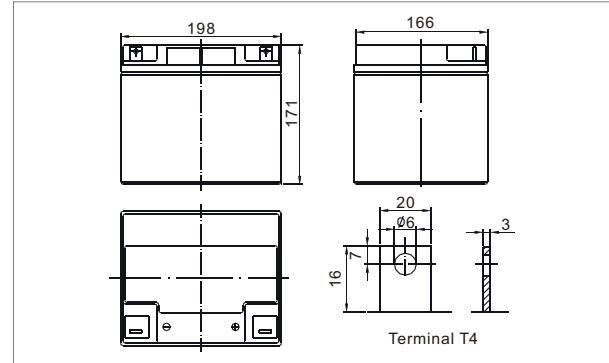

The E&J 12V 40Ah lithium iron phosphate battery (LiFePO₄ battery) have PCM (protection circuit module) electronics inside. The PCM manages the internal cells and provides overcharge and discharge protection. E&J 12V lithium batteries, due to the light weight of the lithium element, have the highest energy density among batteries. They have 3 times more energy per weight and volume than the VRLA batteries. E&J 12V LiFePO₄ battery may simply drop in as a direct replacement for the traditional heavy weight and cumbersome lead acid unit.

1.Application

Alarm System, Medical Equipment, Cable Television, Control Equipment, UPS, Communication Equipment, Toys, Emergency power System, Power Tools, Security System, Golf Trolley/Golf Scooters, ATV

2.Product model and main parameter

Modle	EJ1240Fe
Type	LiFePO ₄ (build in BMS)
Nominal capacity at 0.2C	40Ah
Minimum capacity at 0.2C	39.5Ah
Nominal voltage	12V(12.8V)
Weight	5.8 +/- 0.2 kg
Max continual discharge	40A
Max pulse discharge	100A
Nominal charge current Amps	5A
Max charge current	40A
Max charge voltage	14.6V +/- 0.2
Min discharge voltage	10V
Operating temperature	-20 ~ +60 °C
Charge temperature	0 ~ +45 °C
Storage temperature	-10 ~ +45 °C
Cycle life (80%DOD)	Over 1000 cycles
Dimensions	198*166*171mm

3.Internal protection circuit

Model	4S 40A
Operating current	40A
Peak current	100A for 30S
Max. charge current	40A
Over-voltage protection	3.8V (single cell)
Under-voltage protection	2.2V (single cell)

4.Characters

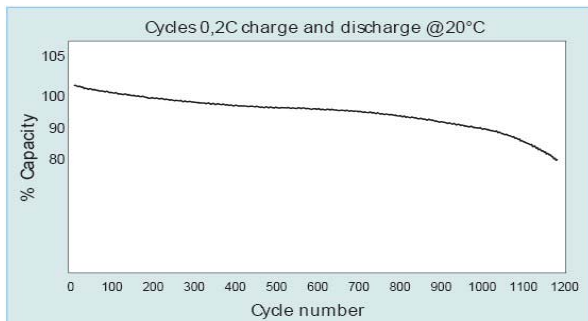
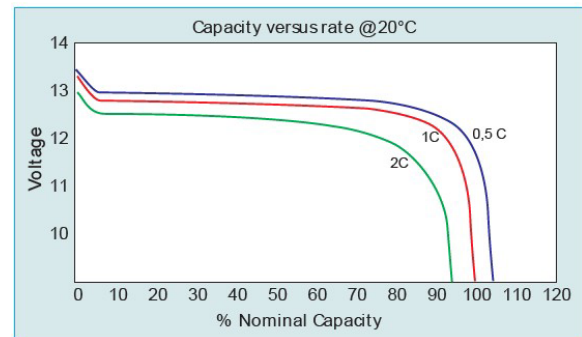
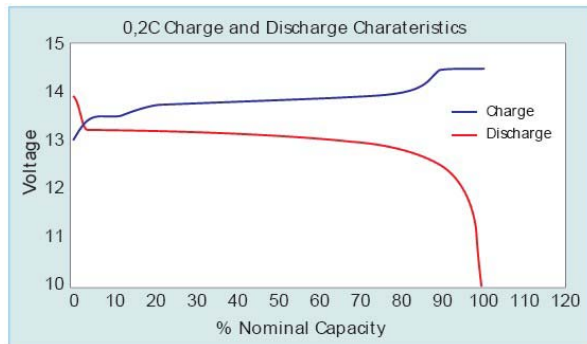

5.Storage and Others

(1) long time storage

If the cell is stored for a long time(exceed three months), the cell should be stored in drying and cooling place. The cell should be charged and discharged each six months. The cell's storage voltage should be 3.2~3.35V.

(2) others

Any matters that this specification does not cover should be covered between the customer and E&J.

6.Warranty Period& Product Liability

One year warranty period begins from the delivery date.

E&J is not responsible for the incident caused by not obeying the specifications.

When the specification is modified, E&J does not inform the customer.