

Single specification		
Product Name		Sealed Nickel Cadmium Cylindrical Rechargeable Battery
Model		<b>EJD-AA700</b>
Nominal Voltage		1.2V
Nominal	Capacity	700mAh
Dimension (with tube)	Diameter	14.5 <sup>+0</sup> / <sub>-0.7</sub>
	Height	50.5 <sup>+0</sup> / <sub>-1.0</sub>
Internal Resistance at 1000Hz		≤ 25mΩ (After charge)
Charge	Standard	70mA × 16h
	Rapid	700mA × 1.5h
	Trickle	21~35mA
Discharge Cut-off Voltage		1.0V
Cycle Life		≥ 500 Cycles
Ambient Temperature	Standard Charge	0°C to 45°C
	Rapid Charge	10°C to 40°C
	Trickle Charge	0°C to 45°C
	Discharge	-20°C to 50°C
	Storage	-20°C to 45°C
Ambient Humidity		65±20%

### General Characteristics

Standard charge

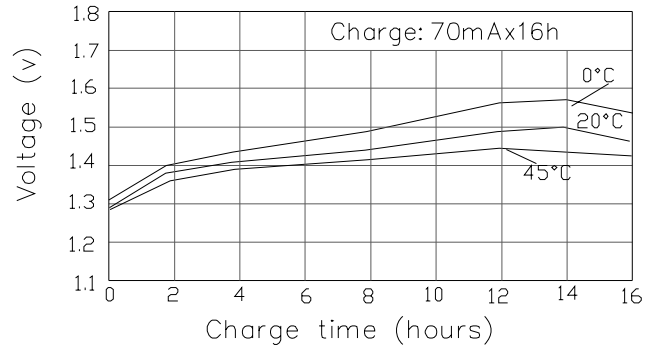

Rapid charge

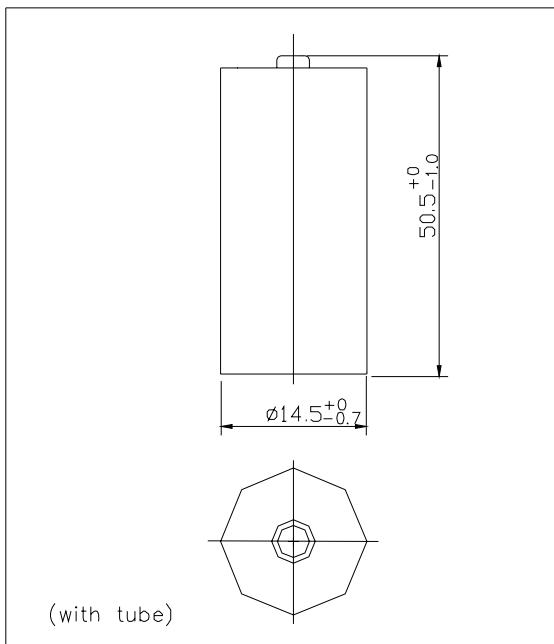
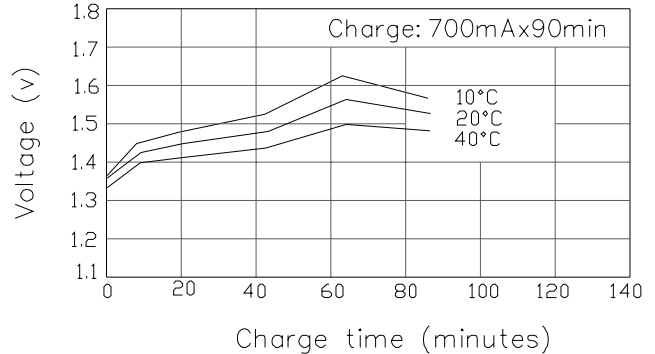

Discharge

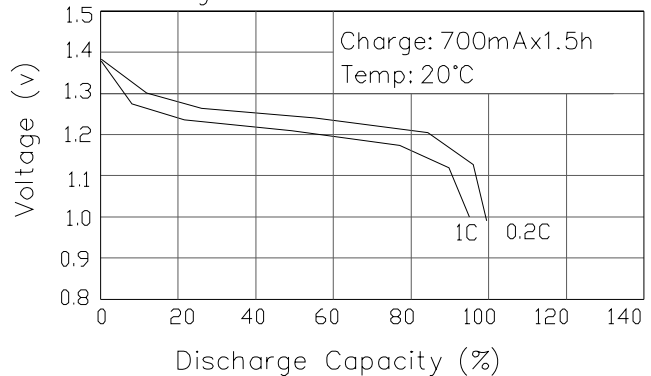

Manufacturer reserves the right to alter or amend the approval sheet without the prior notice