

Single Specification		
Product Name	Sealed Nickel Cadmium Cylindrical Rechargeable Battery	
Model	EJD-C1500	
Nominal Voltage	1.2V	
Nominal Capacity	1500mAh	
Dimension (with tube)	Diameter	25.8 ⁺⁰ _{-1.0}
	Height	51.0 ⁺⁰ _{-1.0}
Internal Resistance at 1000Hz	≤ 15mΩ (After charge)	
Charge	Standard	150mA × 16h
	Rapid	1500mA × 90min
	Trickle	45~75mA
Discharge Cut-off Voltage	1.0V	
Cycle Life	≥ 500 Cycles	
Ambient Temperature	Standard Charge	0°C to 45°C
	Rapid Charge	10°C to 40°C
	Trickle Charge	0°C to 45°C
	Discharge	-20°C to 50°C
	Storage	-20°C to 45°C
Ambient Humidity	65±20%	

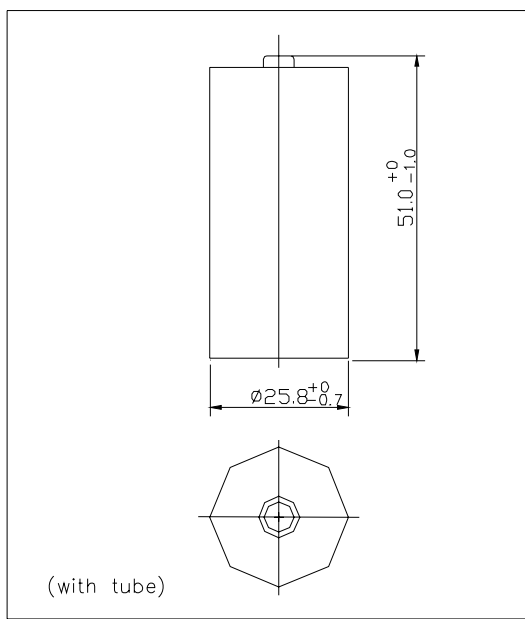

General Characteristics

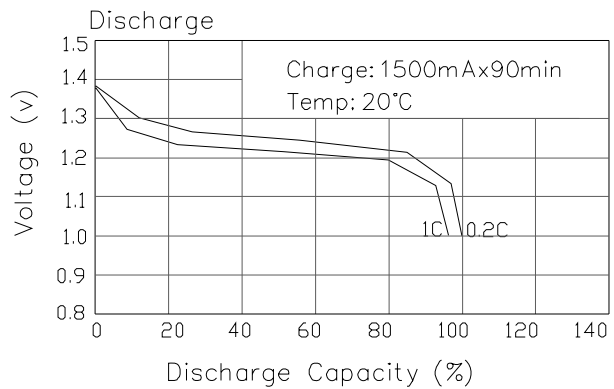
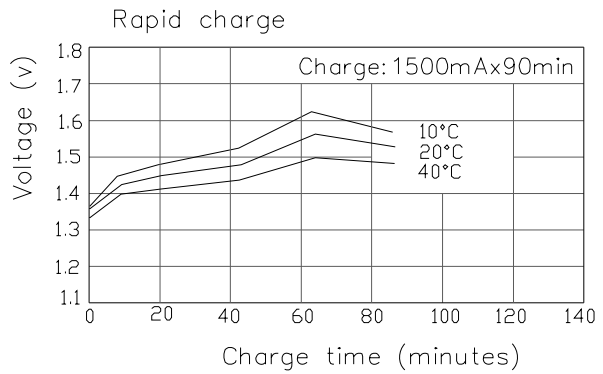
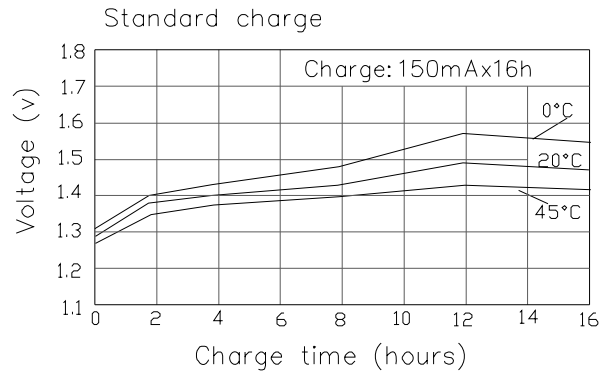

Manufacturer reserves the right to alter or amend the approval sheet without the prior notice