

Product Name		Sealed Nickel Metal Hydride Cylindrical Rechargeable Battery
Model		H9V200
Nominal Voltage		8.4V
Nominal Capacity		200mAh
Dimension (with tube)	Length	26.0±0.2
	Width	17.0±0.2
	Height	MAX 46.3
Internal Resistance at 1000Hz		≤ 800mΩ (After charge)
Charge	Standard	20mA × 16h
	Rapid	60mA × 4h
	Trickle	6~10mA
Discharge Cut-off Voltage		7.0V
Cycle Life		≥ 500 Cycles
Ambient Temperature	Standard Charge	0°C to 45°C
	Rapid Charge	10°C to 40°C
	Trickle Charge	0°C to 45°C
	Discharge	-20°C to 50°C
	Storage	-20°C to 45°C
Ambient Humidity		65±20%

General Characteristics

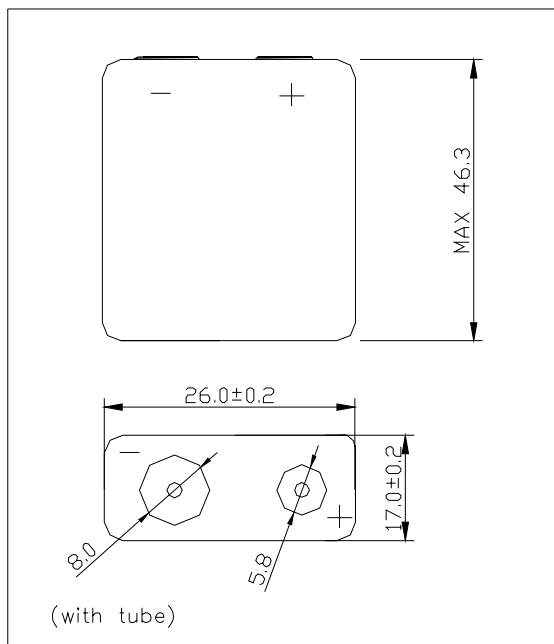
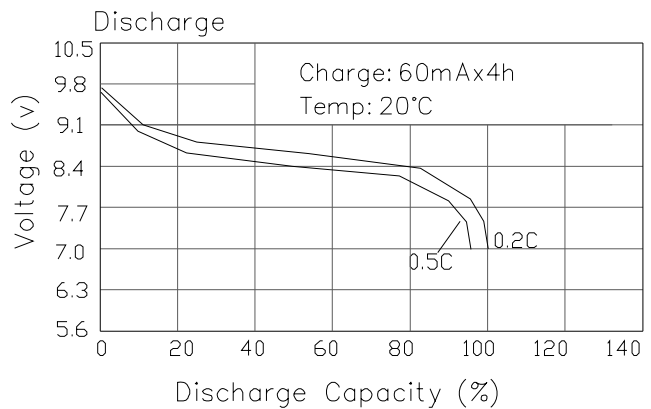
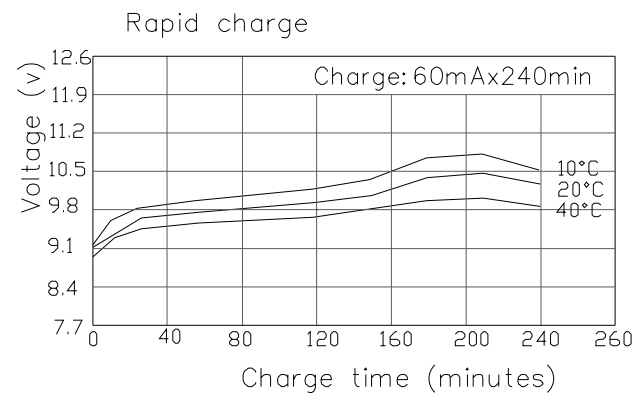
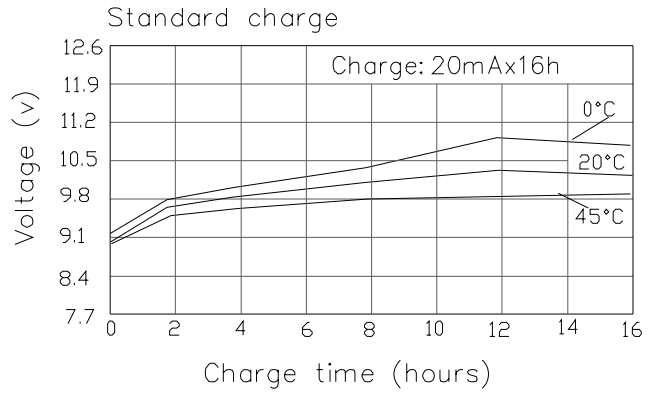

Manufacturer reserves the right to alter or amend the approval sheet without the prior notice